

Noeud: 1 Barres: 1

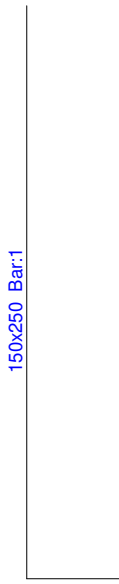

Coupe seule

Noeud: 2 Barres: 2/7

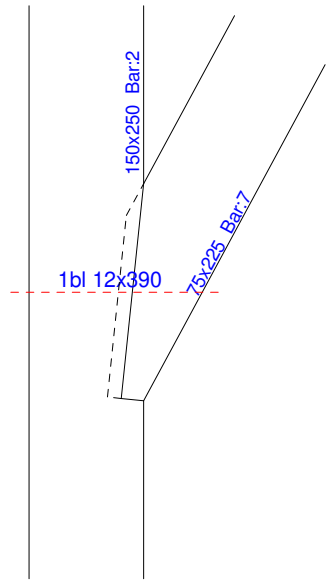

Embrèvement Avant: 49 mm + Tenon

Noeud: 3 Barres: 2/3/10

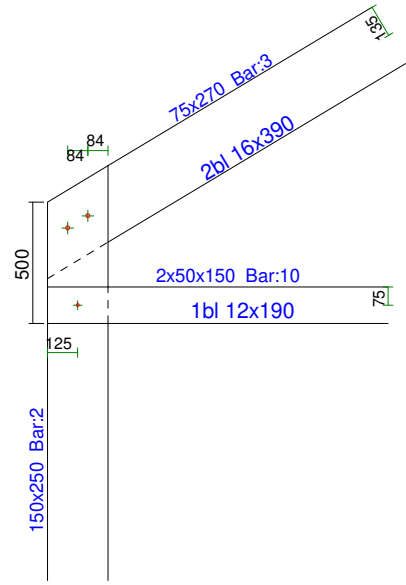

Enfouissement Boulons

Noeud: 4 Barres: 11/6/18

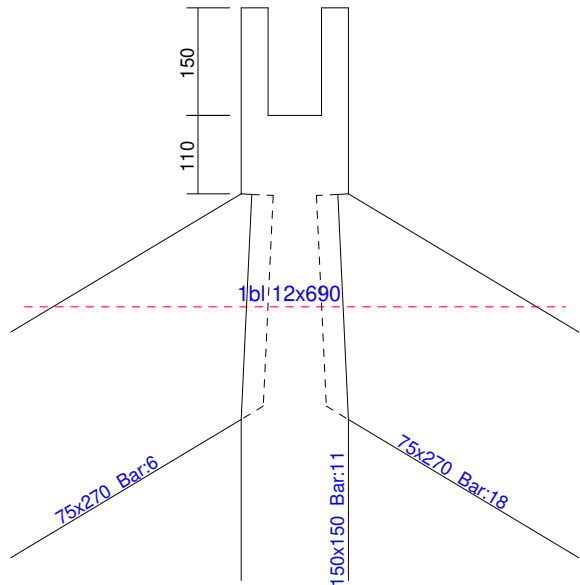

Embrèvement Avant: 15 mm + Tenon

Noeud: 5 Barres: 15/11/12/13

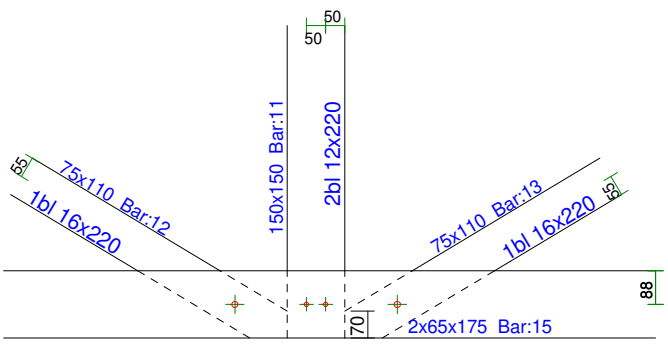

Boulons double Caillement

Noeud: 6 Barres: 9/5

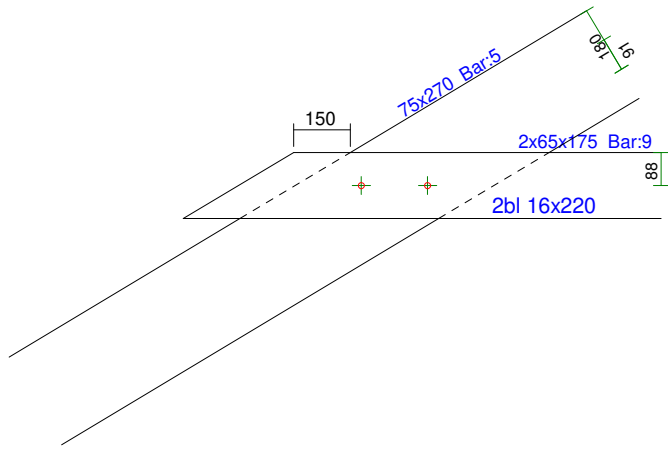

Boulons double Caillement

Commande :  
 Fichier de Calcul :  
 #D mo.Bar  
 Nbre Fermes : 1  
 Bar2020 2D 3D Ver 1.50

Client : **E.D.M.I**  
 Chantier: **EXEMPLE DEMO**  
**E.D.M.I**  
 LOGICIELS STRUCTURE  
 24 rue de Paris 61110 LA MADELEINE BOUVET T l : 02.33.73.53.49

Date: 27/10/2020  
 Page: 1/3  
 Dess: W.B  
 N :

Noeud: 7 Barres: 6/12

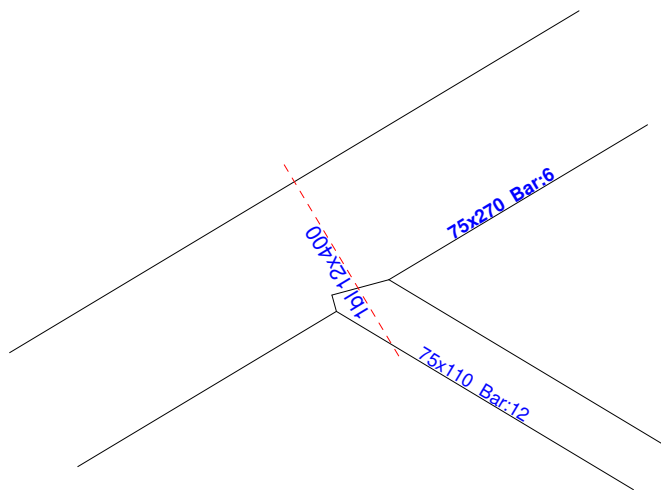

Embrèvement Avant: 33 mm

Noeud: 8 Barres: 4/8

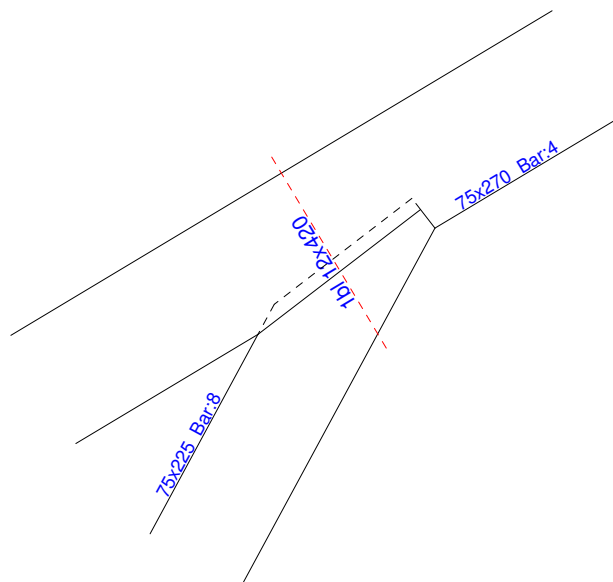

Embrèvement Avant: 50 mm + Tenon

Noeud: 9 Barres: 10/8

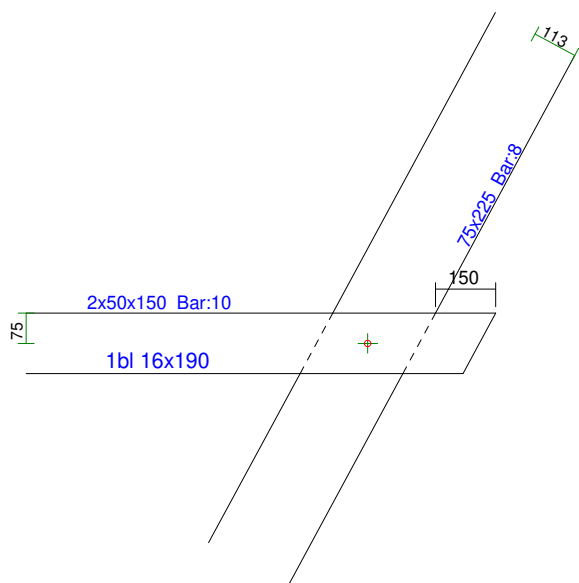

Boulons double Caillement

Noeud: 10 Barres: 14/16

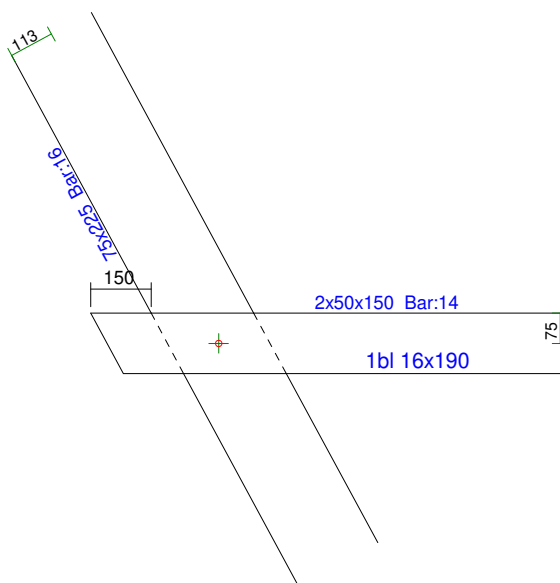

Boulons double Caillement

Noeud: 11 Barres: 20/16

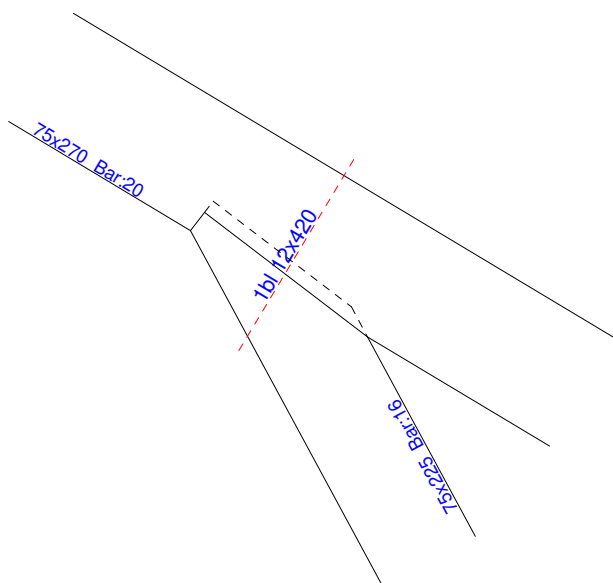

Embrèvement Avant: 49 mm + Tenon

Noeud: 12 Barres: 18/13

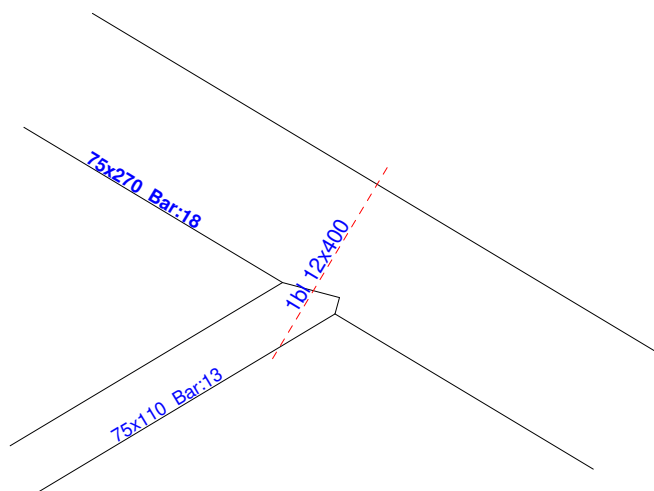

Embrèvement Avant: 33 mm

Commande :  
 Fichier de Calcul :  
 #Démó.Bar  
 Nbre Fermes : 1  
 Bar2020 2D 3D Ver 1.50

Client : **E.D.M.I**  
 Chantier: **EXEMPLE DEMO**  
**E.D.M.I**  
 LOGICIELS STRUCTURE  
 24 rue de Paris 61110 LA MADELEINE BOUVET Tél : 02.33.73.53.49

Date: 27/10/2020  
 Page: 2/3  
 Dess: W.B  
 N°:

**Noeud: 13 Barres: 15/19**

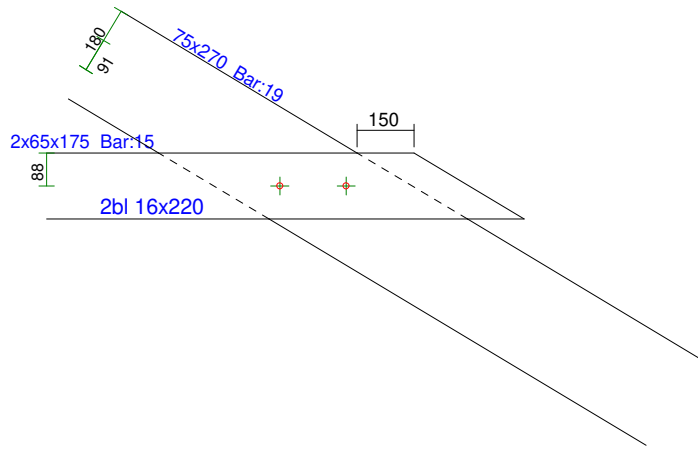

**Boulons double Caillement**

**Noeud: 15 Barres: 22/17**

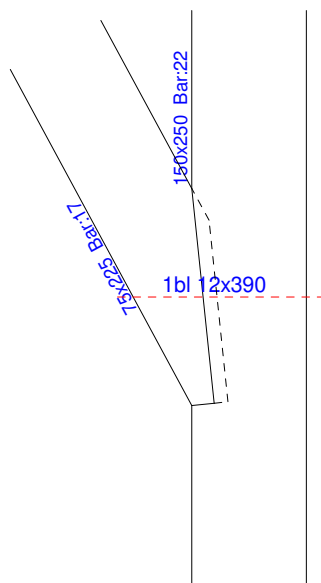

**Embrèvement Avant: 49 mm + Tenon**

**Noeud: 14 Barres: 22/21/14**

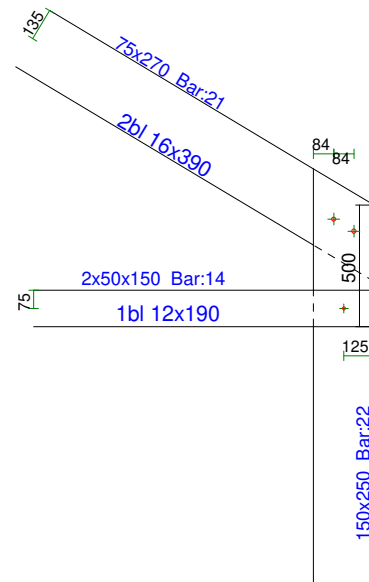

**Enfourchement Boulons**

**Noeud: 16 Barres: 23**

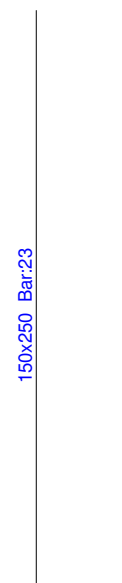

**Coupe seule**

Commande :  
 Fichier de Calcul :  
 #D mo.Bar  
 Nbre Fermes : 1  
 Bar2020 2D 3D Ver 1.50

Client : **E.D.M.I**  
 Chantier: **EXEMPLE DEMO**  
**E.D.M.I**  
 LOGICIELS STRUCTURE  
 24 rue de Paris 61110 LA MADELEINE BOUVET T l : 02.33.73.53.49

Date: 27/10/2020  
 Page: 3/3  
 Dess: W.B  
 N :